

# B70A

## Installation Instructions

EMERGENCY LIGHTING EQUIPMENT

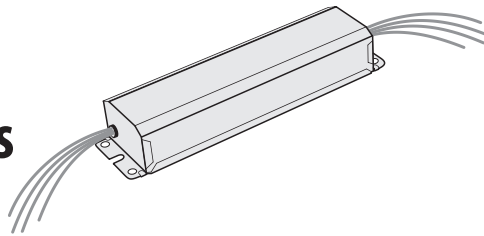

PHILIPS  
**bodine**



### **! IMPORTANT SAFEGUARDS !**

**WHEN USING ELECTRICAL EQUIPMENT, BASIC SAFETY PRECAUTIONS SHOULD ALWAYS BE FOLLOWED, INCLUDING THE FOLLOWING:**

## **READ AND FOLLOW ALL SAFETY INSTRUCTIONS**

1. To prevent high voltage from being present on red & yellow output leads prior to installation, inverter connector must be open. Do not join inverter connector until installation is complete and AC power is supplied to the emergency ballast.
2. This product is for use with most 2' through 8' (17 W - 215 W) single pin or bipin fluorescent lamps, including energy saving, circline, U-shaped and rapid-start (4-pin) long compact fluorescent lamps.
3. Make sure all connections are in accordance with the National Electrical Code and any local regulations.
4. To reduce the risk of electric shock, disconnect both normal and emergency power supplies and inverter connector of the emergency ballast before servicing.
5. This emergency ballast is for factory or field installation in either the ballast channel or on top of the fixture.
6. This product is for use in indoor fixtures except air handling heated air outlets, and wet, damp, or hazardous locations.
7. An unswitched AC power source is required (120 or 277 VAC, 60 Hz).
8. Do not install near gas or electric heaters.
9. Do not attempt to service the battery. A sealed, no-maintenance battery is used that is not field replaceable. Contact the manufacturer for information on service.
10. The use of accessory equipment not recommended by the manufacturer may cause an unsafe condition.
11. Do not use this product for other than intended use.
12. Servicing should be performed by qualified service personnel.

### **SAVE THESE INSTRUCTIONS**



Ni - Cd

**THIS PRODUCT CONTAINS A RECHARGEABLE NICKEL-CADMIUM BATTERY.  
THE BATTERY MUST BE RECYCLED OR DISPOSED OF PROPERLY.**

03/21/11

© Philips Emergency Lighting

A Division of Philips Electronics North America Corporation

236 Mt. Pleasant Rd. • Collierville, TN USA 38017-2752 • Tech Support 888-263-4638 • Fax 901-854-1630 • [www.philips.com/bodine](http://www.philips.com/bodine)  
77000106

# INSTALLATION



**WARNING: TO PREVENT HIGH VOLTAGE FROM BEING PRESENT ON RED & YELLOW OUTPUT LEADS PRIOR TO INSTALLATION, INVERTER CONNECTOR MUST BE OPEN. DO NOT JOIN INVERTER CONNECTOR UNTIL INSTALLATION IS COMPLETE AND AC POWER IS SUPPLIED TO THE EMERGENCY BALLAST.**

NOTE: Make sure the necessary branch circuit wiring is available. An unswitched source of power is required. The emergency ballast must be fed from the same branch circuit as the AC ballast.

## STEP #1 INSTALLING THE EMERGENCY BALLAST

- > Disconnect AC power from the fixture. Remove the ballast channel cover and install the emergency ballast either in the ballast channel or on top of the fixture. \* **Remote mounting distance must be less than half the maximum remote mounting distance for the AC ballast. Consult AC ballast manufacturer before remote installation.**
- > Depending on the type of fixture in use install emergency ballast using one of the methods illustrated below.

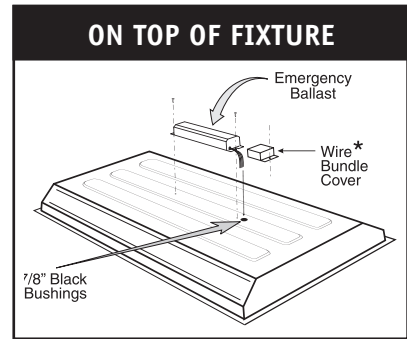
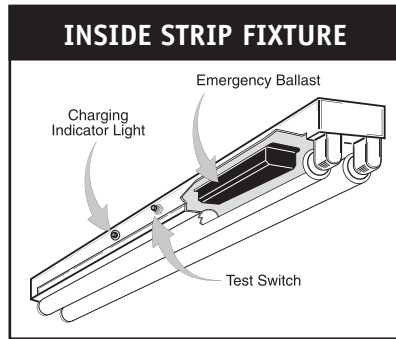
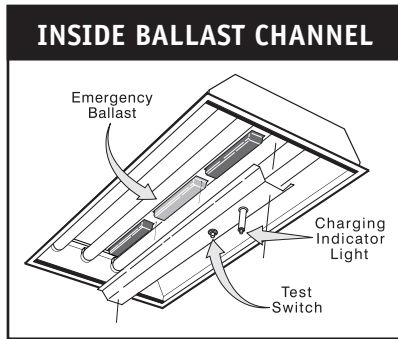

\* For installation on top of the fixture, wire bundle covers (RMC-60) may be required by state or local codes. These covers are available from the manufacturer as an accessory kit and must be ordered separately. Call your local distributor or the factory for complete information.

## STEP #2 INSTALLING THE TEST SWITCH

- > Refer to the illustrations above and install the test switch through the ballast channel cover of a troffer or through the side of a strip fixture.
- > Drill a 1/2" hole and install the switch as shown.
- > Refer to the diagrams on page 4 and wire the test switch so that it removes AC power from the unswitched hot line to the emergency ballast.

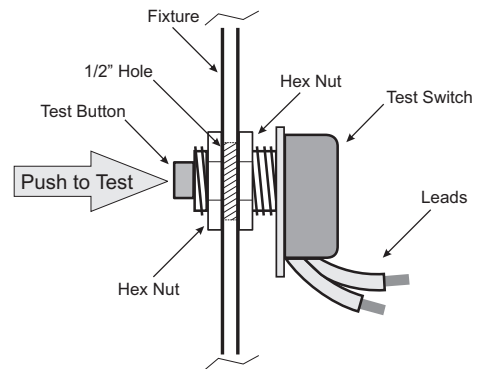

## STEP #3 INSTALLING THE CHARGING INDICATOR LIGHT

- > Install the CHARGING INDICATOR LIGHT as shown in the illustration below so that it will be visible after the fixture is installed.

# INSTALLATION

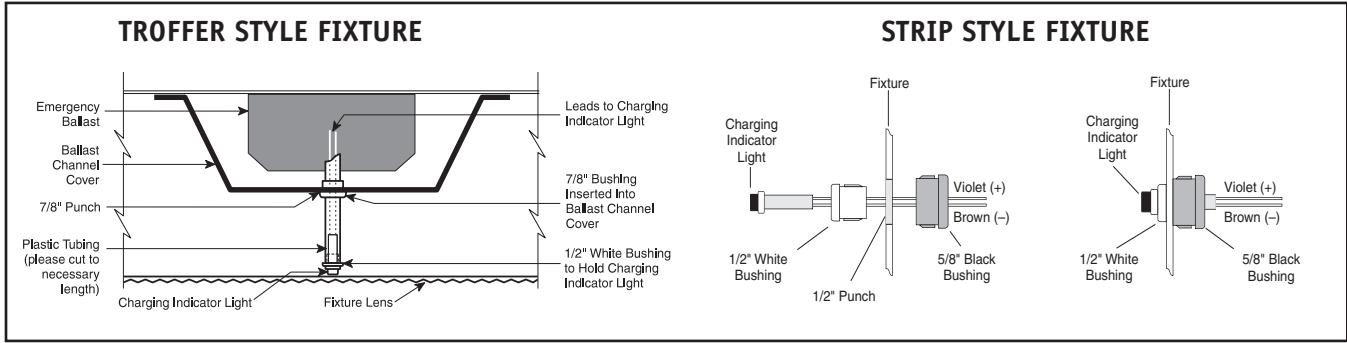

NOTE: After installing the charging indicator light and test switch, mark each with the appropriate label.

## STEP #4 ► WIRING THE EMERGENCY BALLAST

- > Determine the type of AC ballast installed in the fixture.
- > Select the appropriate wiring diagram on back to connect the emergency ballast to the AC ballast and lamp(s). Make sure all connections are in accordance with the National Electrical Code and any local regulations.
- > After installation is complete, supply AC power to the emergency ballast and join the inverter connector.
- > At this point, power should be connected to both the AC ballast and the emergency ballast, and the Charging Indicator Light should illuminate indicating the battery is charging.
- > A short-term discharge test may be conducted after the emergency ballast has been charging for one hour. Charge for 24 hours before conducting a long-term discharge test. Refer to OPERATION.
- > In a readily visible location, attach the label **"CAUTION - This Unit Has More Than One Power Connection Point. To Reduce The Risk Of Electric Shock, Disconnect Both The Branch Circuit-Breakers Or Fuses And Emergency Power Supplies Before Servicing."**

## OPERATION

When AC power is applied, the charging indicator light is illuminated, indicating that the battery is being charged. When power fails, the emergency ballast automatically switches to emergency power (internal battery), operating one lamp at reduced illumination. When AC power is restored, the emergency ballast returns to the charging mode and delays AC ballast operation for approximately three seconds to prevent false-tripping of AC ballast (end-of-lamp-life) shutdown circuits. This emergency ballast will operate the rated lamp load for a minimum of 90 minutes. The emergency ballast also operates one 17 W - 32 W T8, or one 20 W - 40 W T10 or T12 lamp for a minimum of 120 minutes in the emergency mode.

## MAINTENANCE

Although no routine maintenance is required to keep the emergency ballast functional, it should be checked periodically to ensure that it is working. The following schedule is recommended:

1. Visually inspect the charging indicator light monthly. It should be illuminated.
2. Test the emergency operation of the fixture at 30-day intervals for a minimum of 30 seconds. One lamp should operate at reduced illumination.
3. Conduct a 90-minute discharge test once a year. One lamp should operate at reduced illumination for at least 90 minutes.

**! REFER ANY SERVICING INDICATED BY THESE CHECKS TO QUALIFIED PERSONNEL !**

**EMERGENCY BALLAST AND AC BALLAST MUST BE FED FROM THE SAME BRANCH CIRCUIT**  
 TYPICAL SCHEMATICS ONLY. MAY BE USED WITH OTHER BALLASTS. CONSULT THE FACTORY FOR OTHER WIRING DIAGRAMS.

**WIRING DIAGRAMS FOR 1-LAMP EMERGENCY OPERATION**

FIG A ONE (1) LAMP INSTANT START BALLAST

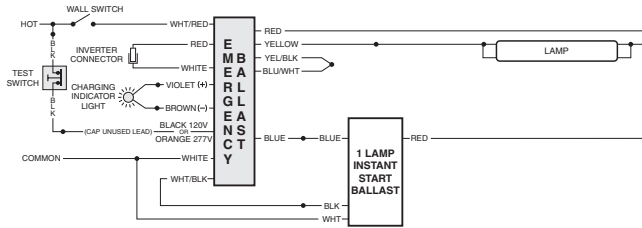

FIG B ONE (1) LAMP RAPID START BALLAST

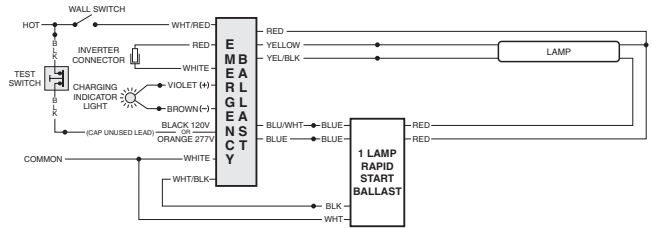

FIG C TWO (2) LAMP INSTANT START BALLAST

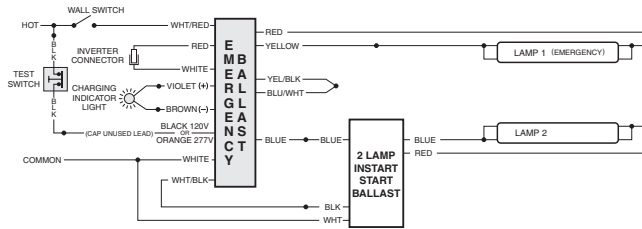

FIG D TWO (2) LAMP RAPID START BALLAST

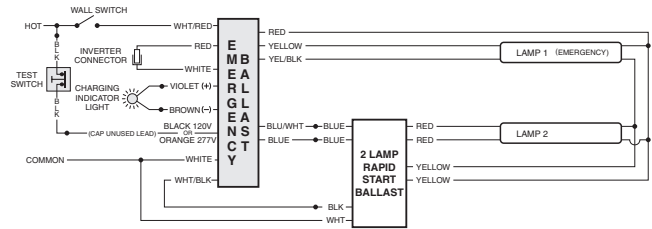

FIG E THREE (3) LAMP INSTANT START BALLAST

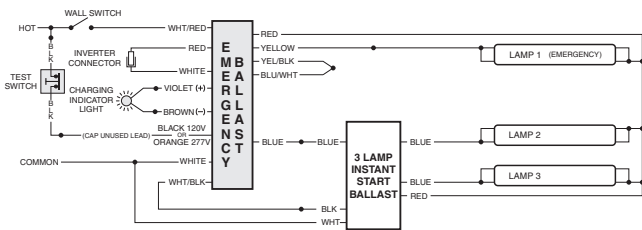

FIG F THREE (3) LAMP RAPID START BALLAST

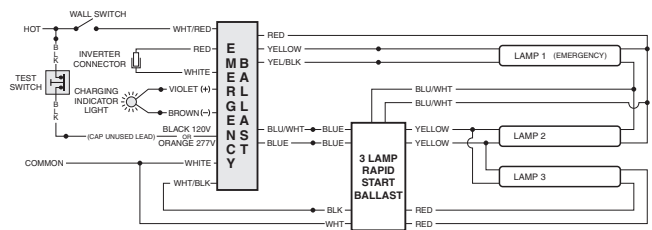

FIG G FOUR (4) LAMP INSTANT START BALLAST

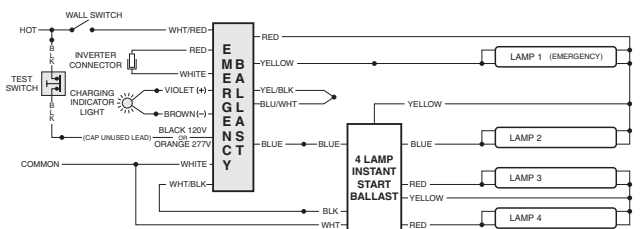

FIG H FOUR (4) LAMP RAPID START BALLAST

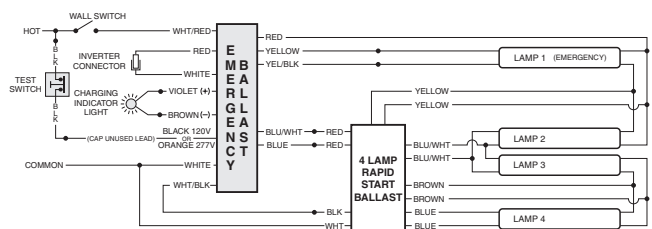
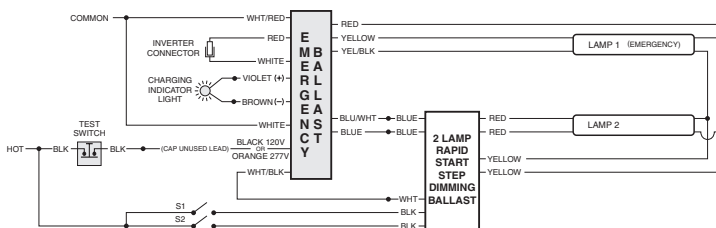

FIG I TWO (2) LAMP RAPID START STEP DIMMING BALLAST



THE WHITE/BLACK LEAD MUST CONNECT TO THE WHITE LEAD OF THE STEP-DIMMING BALLAST ASSOCIATED WITH THE EMERGENCY BALLAST ONLY. CONNECTIONS TO OTHER BALLASTS OR FIXTURES COULD RESULT IN ABNORMAL OPERATION AND CAUSE PRODUCT DAMAGE.

**WIRING DIAGRAM for EMERGENCY-ONLY fixtures**

FIG J ONE (1) 17-215 W LAMP WITHOUT AC BALLAST

