

# B50ST<sup>REDiTEST</sup>

## Installation Instructions

SELF-TESTING EMERGENCY EQUIPMENT  
UNIVERSAL INPUT

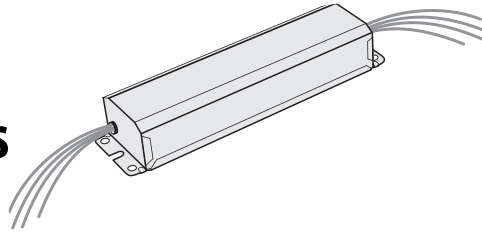

PHILIPS  
**bodine**



### **! IMPORTANT SAFEGUARDS !**

**WHEN USING ELECTRICAL EQUIPMENT, BASIC SAFETY PRECAUTIONS SHOULD ALWAYS BE FOLLOWED, INCLUDING THE FOLLOWING:**

## **READ AND FOLLOW ALL SAFETY INSTRUCTIONS**

1. To prevent high voltage from being present on red & yellow output leads prior to installation, inverter connector must be open. Do not join inverter connector until installation is complete and AC power is supplied to the emergency ballast.
2. This product is for use with one 17 W through 215 W (2' - 8') or two 17 W through 40 W (2' - 4') single pin or bipin fluorescent lamps, including standard, energy saving, HO, VHO, circline, U-shaped and rapid-start fluorescent lamps.
3. Make sure all connections are in accordance with the National Electrical Code or Canadian Electrical Code and any local regulations.
4. To reduce the risk of electric shock, disconnect both normal and emergency power supplies and inverter connector of the emergency ballast before servicing.
5. This emergency ballast is for factory or field installation in either the ballast channel, on top of, or remote from the fixture.
6. This product is suitable for damp locations where the ambient temperature is 0°C minimum, +50°C maximum. Product is also suitable for installation in sealed and gasketed fixtures. Product is not suitable for heated air outlets and wet or hazardous locations.
7. An unswitched AC power source is required. (120 through 277 VAC, 50/60Hz)
8. Do not install near gas or electric heaters.
9. Do not attempt to service the battery. A sealed, no-maintenance battery is used that is not field replaceable. Contact the manufacturer for information on service.
10. The use of accessory equipment not recommended by the manufacturer may cause an unsafe condition.
11. Do not use this product for other than intended use.
12. Servicing should be performed by qualified service personnel.

**CAUTION:** Verify that all replacement lamp types marked on the installed luminaire are also identified as suitable for use with this inverter/charger pack.

## **SAVE THESE INSTRUCTIONS**

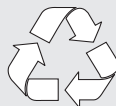

Ni - Cd

**THIS PRODUCT CONTAINS A RECHARGEABLE NICKEL-CADMIUM BATTERY.  
THE BATTERY MUST BE RECYCLED OR DISPOSED OF PROPERLY.**

01/16/15

© Philips Emergency Lighting

236 Mt. Pleasant Rd. • Collierville, TN USA 38017-2752 • Tech Support 888-263-4638 • Fax 901-853-5009 • www.bodine.com  
443529081681

# INSTALLATION

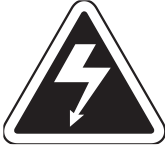

**WARNING: TO PREVENT HIGH VOLTAGE FROM BEING PRESENT ON RED & YELLOW OUTPUT LEADS PRIOR TO INSTALLATION, INVERTER CONNECTOR MUST BE OPEN. DO NOT JOIN INVERTER CONNECTOR UNTIL INSTALLATION IS COMPLETE AND AC POWER IS SUPPLIED TO THE EMERGENCY BALLAST.**

**NOTE:** Make sure the necessary branch circuit wiring is available. An unswitched source of power is required. The emergency ballast must be fed from the same branch circuit as the AC ballast.

## STEP #1 ▶ INSTALLING THE EMERGENCY BALLAST

- > Disconnect AC power from the fixture. Remove the ballast channel cover and install the emergency ballast either in the ballast channel or on top of the fixture.\* **Remote mounting distance must be less than half the maximum remote mounting distance for the AC ballast. Consult AC ballast manufacturer before remote installation.**
- > Depending on the type of fixture in use install emergency ballast using one of the methods illustrated below.

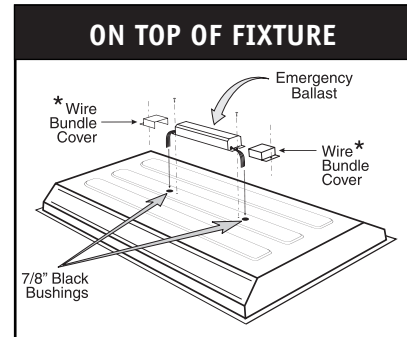
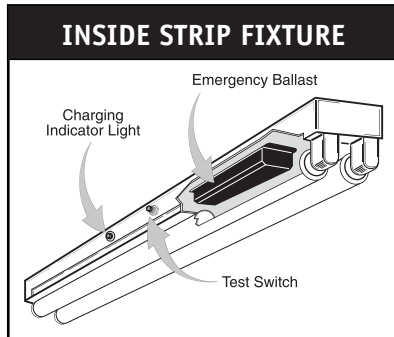
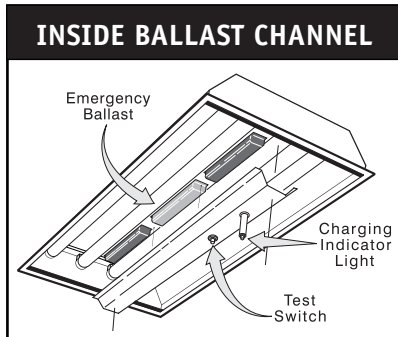

\* For installation on top of the fixture, wire bundle covers (RMC-60) may be required by state or local codes. These covers are available from the manufacturer as an accessory kit and must be ordered separately. Call your local distributor or the factory for complete information.

## STEP #2 ▶ INSTALLING THE TEST SWITCH

- > Refer to the illustrations above and install the test switch through the ballast channel cover of a troffer or through the side of a strip fixture.
- > Drill a 1/2" hole and install the switch as shown.
- > Wire the test switch so that it removes AC power from both the emergency ballast and the AC ballast at the same time. (see wiring diagrams)

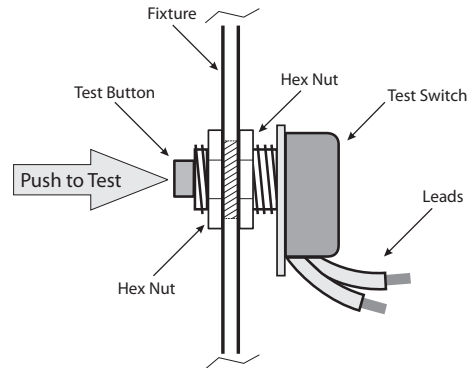

## STEP #3 ▶ INSTALLING THE CHARGING INDICATOR LIGHT

- > Install the CHARGING INDICATOR LIGHT as shown in the illustration on the following page so that it will be visible after the fixture is installed.

# CHARGING INDICATOR LIGHT INSTALLATION

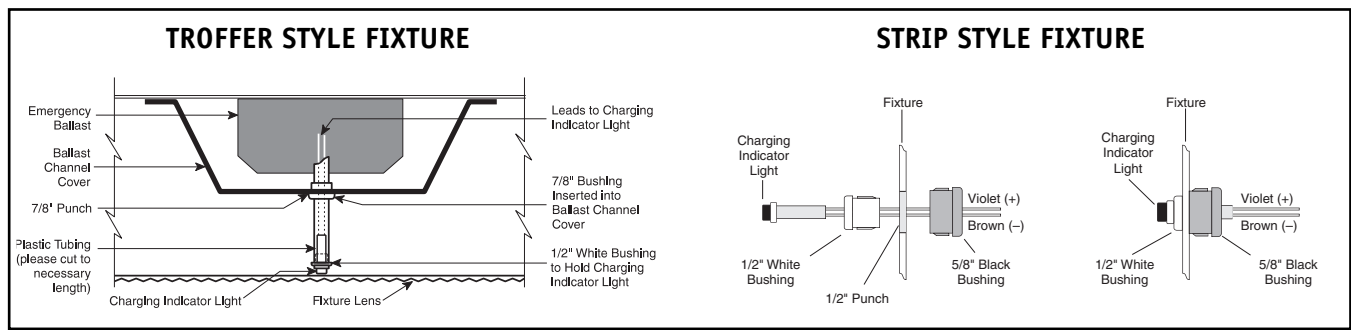

## STEP #4 ► WIRING THE EMERGENCY BALLAST

- > Determine the type of AC ballast installed in the fixture.
- > Select the appropriate wiring diagram on back to connect the emergency ballast to the AC ballast and lamp(s). Make electrical connections in accordance with the National Electrical Code and any local regulations.
- > After installation is complete, supply AC power to the emergency ballast and join the inverter connector. It is normal for the indicator light to remain off for a few minutes on initial start-up, as the battery voltage rises to normal range. Refer to **Troubleshooting Guide** if this condition persists.
- > At this point, power should be connected to both the AC ballast and the emergency ballast, and the Charging Indicator Light should illuminate indicating the battery is charging.
- > A short-term discharge test may be conducted after the emergency ballast has been charging for one hour. Charge for 24 hours before conducting a long-term discharge test. Refer to OPERATION.
- > In a readily visible location, attach the label **"CAUTION - This Unit Has More Than One Power Connection Point. To Reduce The Risk Of Electric Shock, Disconnect Both The Branch Circuit-Breakers Or Fuses And Emergency Power Supplies Before Servicing."**

## OPERATION

During normal operation, AC power is applied and the self-testing emergency ballast charges the battery. Connecting the (red and white) inverter connector wires enables the emergency circuit, and supplies power to the control/monitor circuit and charging indicator light. The self-testing emergency ballast continually monitors the charging current and battery voltage, comparing them to preset limits. Should the unit detect an unusual current or voltage condition, the indicator light will flash a pattern as mentioned in the troubleshooting guide until the condition has been corrected or the unit passes the next test.

When AC power fails, the self-testing emergency ballast automatically switches to emergency mode, keeping either one or two lamps illuminated at a reduced lumen output for a minimum of 90 minutes. When AC power is restored, the self-testing emergency ballast returns to charging mode and delays AC ballast operation for approximately three seconds to prevent false tripping of AC ballast (end-of-lamp life) shutdown circuits.

## SELF-TESTING OPERATION

This unit contains a control/monitor circuit that automatically performs a 30-second discharge test every 30 days, and a full 90-minute discharge test once a year. During routine testing, the self-testing emergency ballast simulates an AC power failure causing the unit to automatically switch to emergency mode. The unit will monitor the operation of the lamps, battery voltage, discharge current, and emergency duration. If the emergency system functions properly, then the unit will return to normal mode. Should the unit detect any problems, the indicator light will flash a pattern as mentioned in the troubleshooting guide until the condition has been corrected or the unit passes the next test.

To reset a failure indication, push and hold the test switch for a minimum of 15 seconds. If the condition has not been corrected by the next scheduled test, the unit will once again detect the failure and signal the failure indicator.

To cancel a test, turn the wall switch ON (or OFF if switch is already on), wait five seconds, then turn it OFF (ON).

# MAINTENANCE

This self-testing emergency ballast automatically performs required routine testing. Results are reported to maintenance personnel via the indicator light.

**Note:** Maintenance personnel should periodically check the indicator light. If the indicator light is flashing, go through all steps of Troubleshooting Guide.

## TROUBLESHOOTING GUIDE

STATUS INDICATOR	PROBLEM	CORRECTIVE ACTION
Light on steady, not flashing	None	None, Unit is Operating Correctly.
Flashing 2 times every 10 seconds	Battery voltage is outside limits	Let battery charge. If after an hour failure is still indicated, see action below.
Flashing 3 times every 10 seconds	Battery charging current is outside limits	Check that fixture wiring is in accordance with proper wiring diagram.
Flashing 4 times every 10 seconds	Battery discharge is too low during scheduled self test	<ol style="list-style-type: none"> <li>1. Check to make sure lamps are good (operational and specified for self-testing emergency ballast) and in place.</li> <li>2. Check to see if brown connector is properly used. (See Table 1.)</li> <li>3. Check that fixture wiring is in accordance with proper wiring diagram.</li> <li>4. Allow unit to charge for 24 hours. Perform manual test. If flashing continues, emergency ballast should be replaced.</li> </ol>
Continuous fast flashing	Battery discharge is too high during scheduled self test	

### Failure Status will be reset when the unit passes:

- The next automatic test, or
- A manual test exceeding 15 seconds, or
- An actual power failure exceeding 15 seconds.

## B50ST WIRING DIAGRAMS

The following diagrams are typical schematics only. May be used with other ballasts. Consult the factory for other wiring diagrams. Emergency Ballast and AC Ballast must be fed from the SAME BRANCH CIRCUIT.

**IMPORTANT TEXT: REFER TO TABLE 1 REGARDING BROWN CONNECTOR**

**Table 1**

LAMP (DIAMETER)	BASE TYPE	WATTAGE (Length)	NO. of LAMPS (EMERGENCY-MODE)	BROWN CONNECTOR
T8,T9,T10,T12 (1", 1¼", 1½")	Single or Bipin	17 - 40 W (2'-4')	1	CLOSED
			2	OPEN
		40 - 215 W (5' -8')	1	OPEN

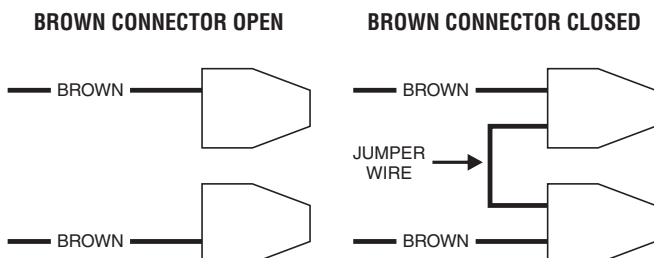

# WIRING DIAGRAM for 1-LAMP emergency operation

FIG A ONE (1) LAMP RAPID START BALLAST

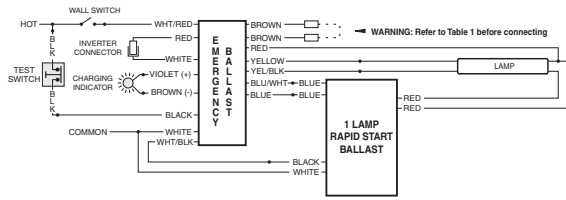

FIG B ONE (1) LAMP INSTANT START BALLAST

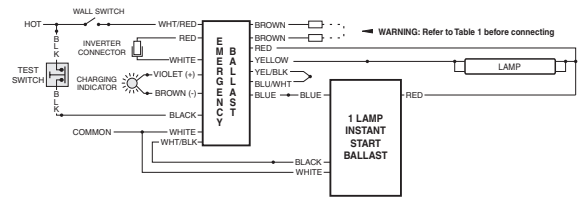

FIG C TWO (2) LAMP RAPID START BALLAST

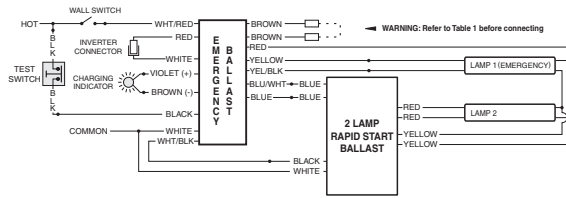

FIG D TWO (2) LAMP INSTANT START BALLAST

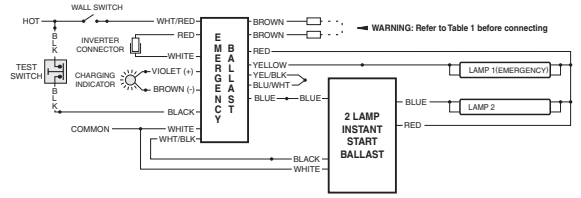

FIG E THREE (3) LAMP RAPID START BALLAST

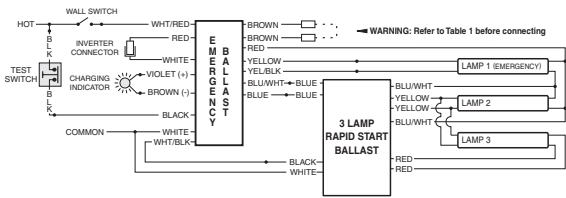

FIG F THREE (3) LAMP INSTANT START BALLAST

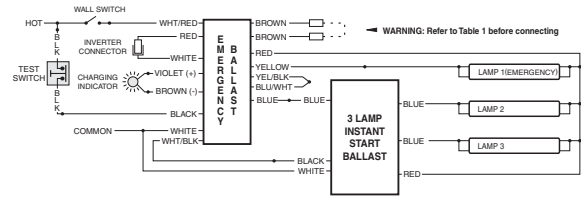

FIG G FOUR (4) LAMP RAPID START BALLAST

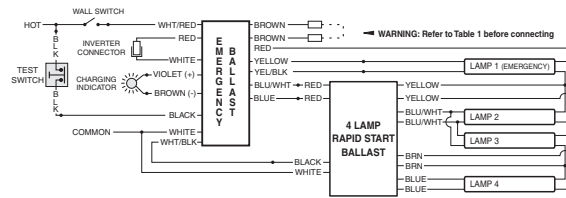
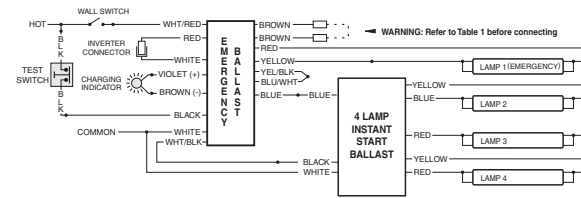

FIG H FOUR (4) LAMP INSTANT START BALLAST



**EMERGENCY BALLAST AND AC BALLAST MUST BE FED FROM THE SAME BRANCH CIRCUIT**  
 TYPICAL SCHEMATICS ONLY. MAY BE USED WITH OTHER BALLASTS. CONSULT THE FACTORY FOR OTHER WIRING DIAGRAMS.

# WIRING DIAGRAM for 1-LAMP emergency operation

FIG I ONE (1) LAMP COMPACT RAPID START BALLAST

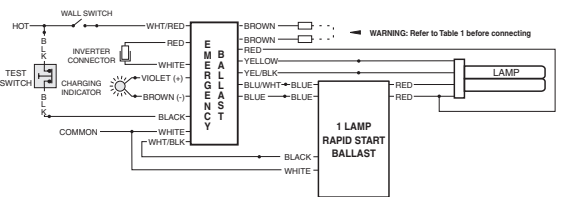

FIG J TWO (2) LAMP COMPACT RAPID START BALLAST

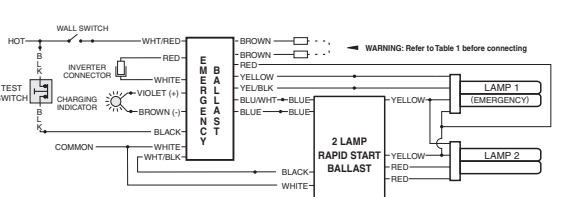
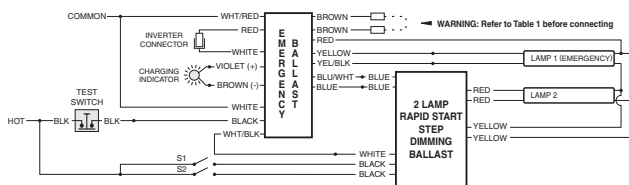

FIG K TWO (2) LAMP RAPID START STEP DIMMING BALLAST



THE WHITE/BLACK LEAD MUST CONNECT TO THE WHITE LEAD OF THE STEP-DIMMING BALLAST ASSOCIATED WITH THE EMERGENCY BALLAST ONLY. CONNECTIONS TO OTHER BALLASTS OR FIXTURES COULD RESULT IN ABNORMAL OPERATION AND CAUSE PRODUCT DAMAGE.

# WIRING DIAGRAMS for 2-LAMP emergency operation (2'- 4', 17- 40 W lamps only)

Two-lamp emergency operation is not possible with all ballasts.  
Consult the factory for any ballast other than those shown.

FIG L TWO (2) LAMP RAPID START BALLAST

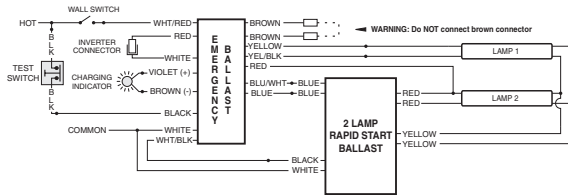

FIG M TWO (2) LAMP INSTANT START BALLAST

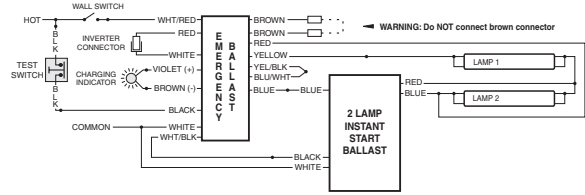

FIG N THREE (3) LAMP RAPID START BALLAST

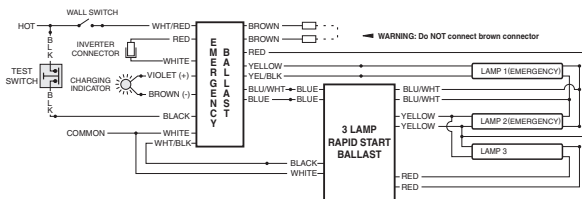

FIG O THREE (3) LAMP INSTANT START BALLAST

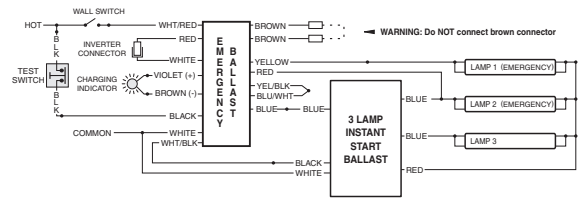

FIG P FOUR (4) LAMP RAPID START BALLAST

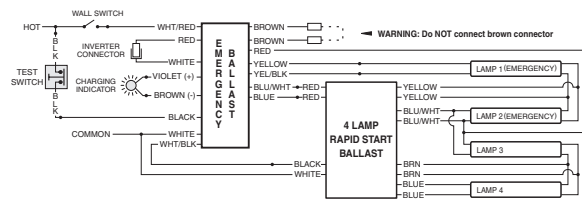

FIG Q FOUR (4) LAMP INSTANT START BALLAST

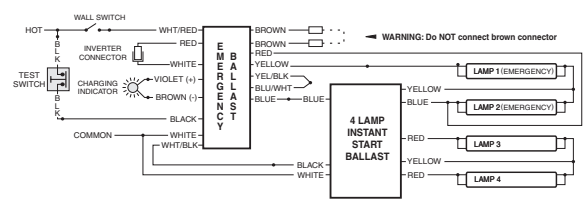
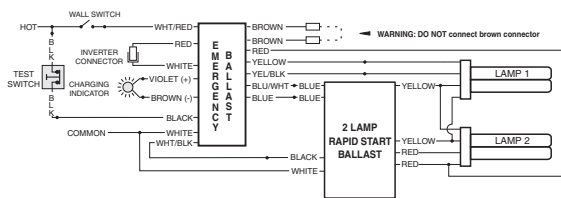

FIG R TWO (2) COMPACT LAMP RAPID START BALLAST



## WIRING DIAGRAMS for Emergency-Only fixtures

FIG S ONE (1) LAMP WITHOUT AC BALLAST (16W-215W)

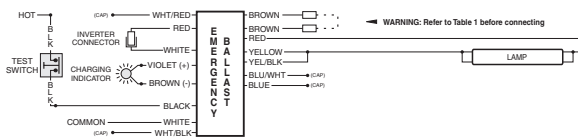

FIG T TWO (2) LAMPS WITHOUT AC BALLAST (17W-40W)

